







# E12BN10

 Single layer	
 Fix centring	 2+ Heating zone(s)
 Die adjustment	

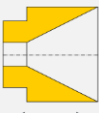
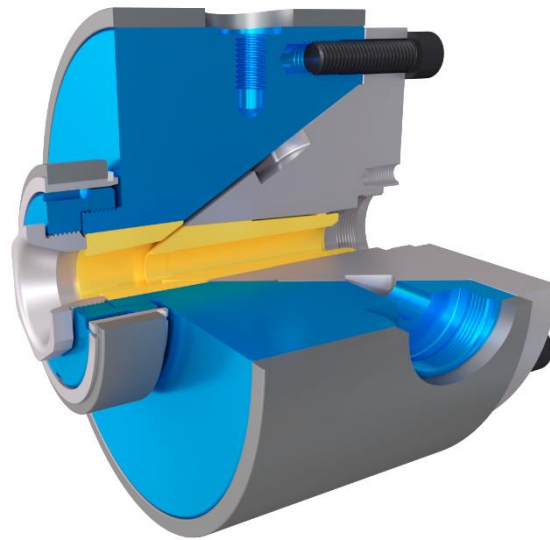



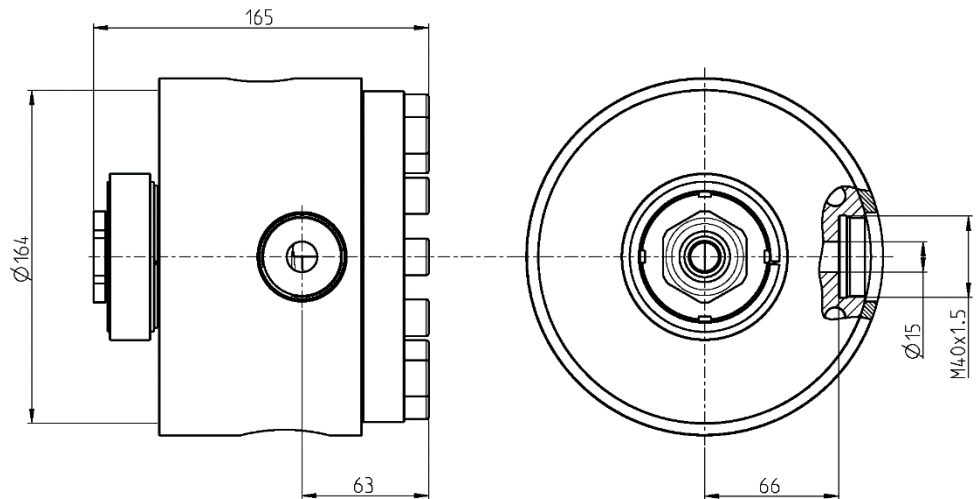



- Power cable 
- Data cable 
- Special shaped 
- Tube 

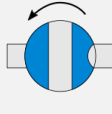
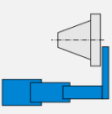

Version	Maximum opening of the Tip	Maximum opening of the Die	Main entry port / thread		Auxiliary entry port / thread		Total length	Crosshead diameter	Max. working temperature	Max. working pressure	Weight
			A	B	C	D					
-	14 mm	20 mm	15 mm	M40x1.5	-	-	165 mm	164 mm	<250°C	500 bars	22 kg

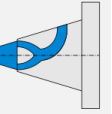
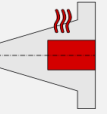
## Options

 Vacuum connection	 Extruder connection	 Bypass module	 Telescopic maintenance device	 Trolley or stand	 Customized distributor	 Heated distributor	 300°C Reinforced heaters		
--	--	--	--	---	---	--	---	--	--