











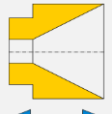

# E12K 12.3.0

 Multi-layers	 Skin coloration
 Striping	 Single layer
 Fix centring	 2 Heating zone(s)
 Die adjustment	
 Intermediate Die available	

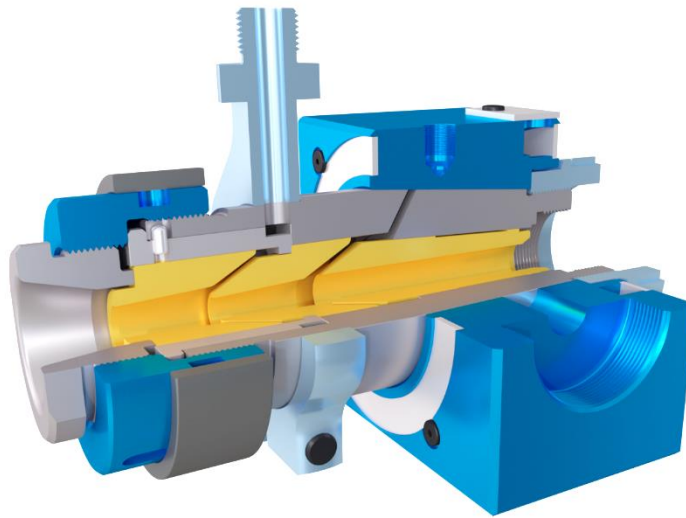



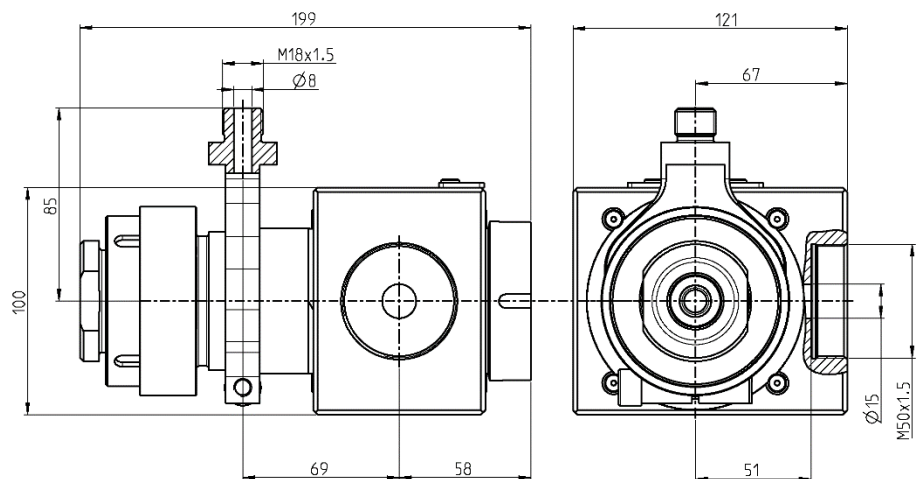

- Power cable 
- Data cable 
- Special shaped 
- Tube 



Version	Maximum opening of the Tip	Maximum opening of the Die	Main entry port / thread		Auxiliary entry port / thread		Total length	Crosshead diameter	Max. working temperature	Max. working pressure	Weight
			A	B	C	D					
-	14 mm	20 mm	15 mm	M50x1.5	8 mm	M18x1.5	199 mm	100 mm	<250°C	500 bars	10 kg

## Options

 Vacuum connection	 Extruder connection	 Trolley or stand	 300°C Reinforced heaters							
--	--	---	---	--	--	--	--	--	--	--