







E25BF10

 Single layer	
 Fix/manual centring	 3 Heating zone(s)
 Die adjustment	

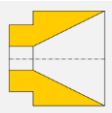



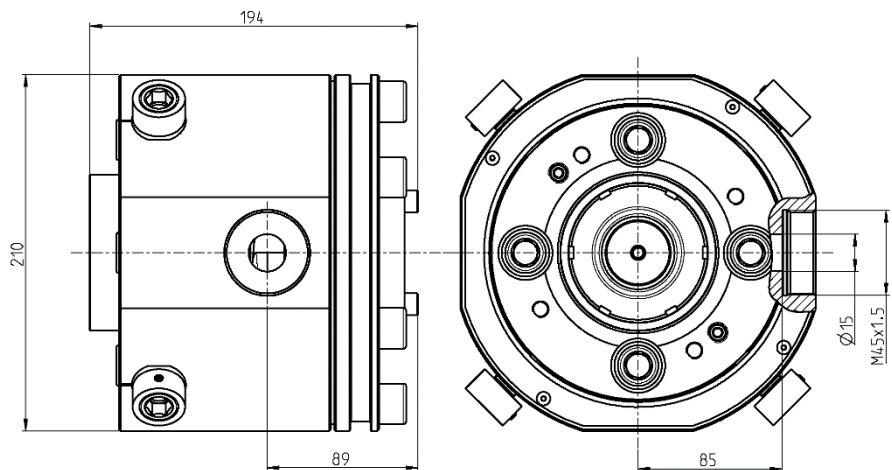

- Power cable 
- Data cable 
- Special shaped 
- Tube 

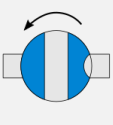
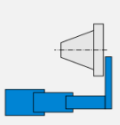

Version	Maximum opening of the Tip	Maximum opening of the Die	Main entry port / thread		Auxiliary entry port / thread		Total length	Crosshead diameter	Max. working temperature	Max. working pressure	Weight
			A	B	C	D					
	25 mm	35 mm	15 mm	M45x1.5	-	-	194 mm	210 mm	<400°C	400 bars	41 kg

Options

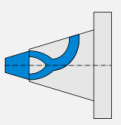
 Vacuum connection	 Extruder connection	 Bypass module	 Telescopic maintenance device	 Trolley or stand	 Customized distributor					
--	--	--	--	---	---	--	--	--	--	--