













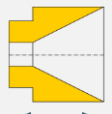
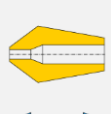

# E35GN20

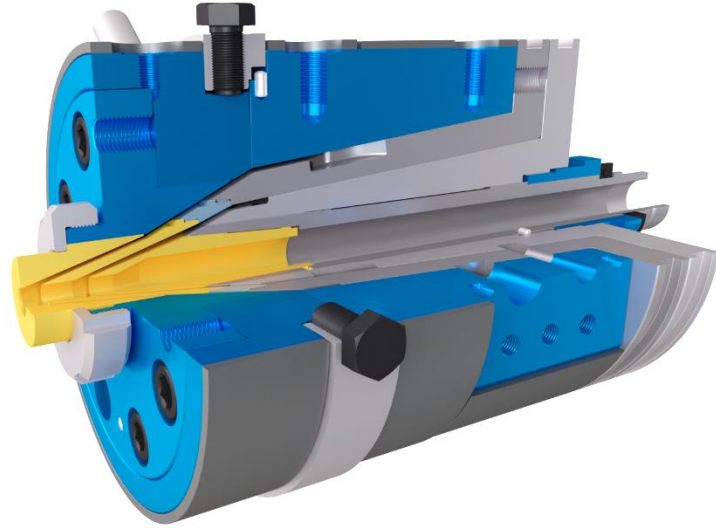
|   |  |
|---|--|
| <br>Multi-layers                 | <br>Skin coloration   |
| <br>Sectoral                     | <br>Single layer      |
| <br>Fix/manual centring          | <br>3 Heating zone(s) |
| <br>Die adjustment             | <br>Tip adjustment  |
| <br>Intermediate Die available |  |





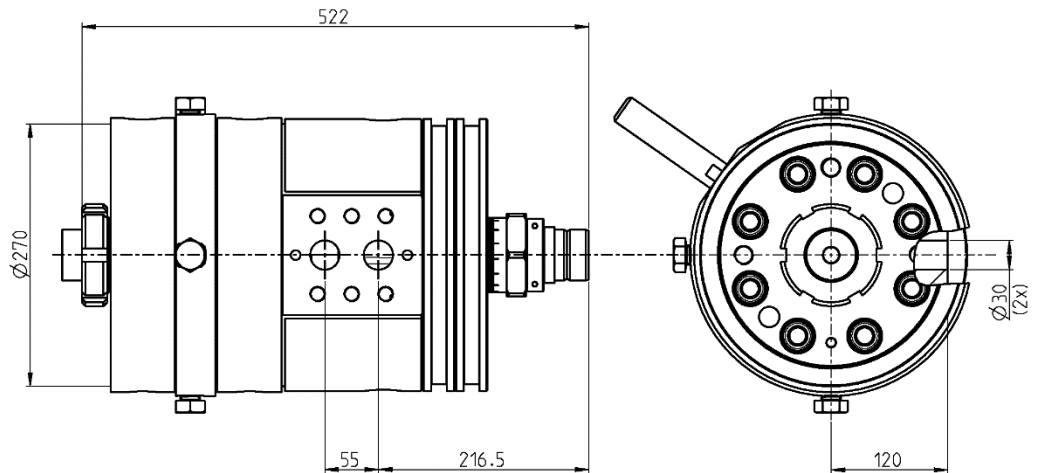

|                  |   |
|------------------|---|
| Power cable      |  |
| Data cable       |  |
| Special shaped   |  |
| Tube             |  |
| Multi-layer tube |  |
| HV/MV cable      |  |

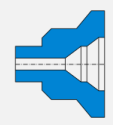
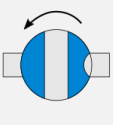
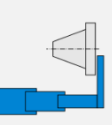

| Version | Maximum opening of the Tip | Maximum opening of the Die | Main entry port / thread |   | Auxiliary entry port / thread |   | Total length | Crosshead diameter | Max. working temperature | Max. working pressure | Weight |
|---------|----------------------------|----------------------------|--------------------------|---|-------------------------------|---|--------------|--------------------|--------------------------|-----------------------|--------|
|         |                            |                            | A                        | B | C                             | D |              |                    |                          |                       |        |
| -       | 35 mm                      | 45 mm                      | 30 mm                    | - | -                             | - | 522 mm       | 270 mm             | <250°C                   | 500 bars              | 177 kg |

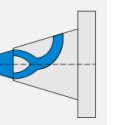
## Options

|  |  |  |  |   |   |  |  |  |  |  |
|--|--|--|--|---|---|--|--|--|--|--|
| <br>Vacuum connection | <br>Extruder connection | <br>Bypass module | <br>Telescopic maintenance device | <br>Trolley or stand | <br>Customized distributor | <br>300°C Reinforced heaters |  |  |  |  |
|--|--|--|--|---|---|--|--|--|--|--|