







# E3AN10 FT

 Single layer	
<b>FT</b> Fine-tuning centring	<b>2</b>  Heating zone(s)
 Die adjustment	

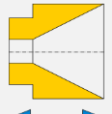
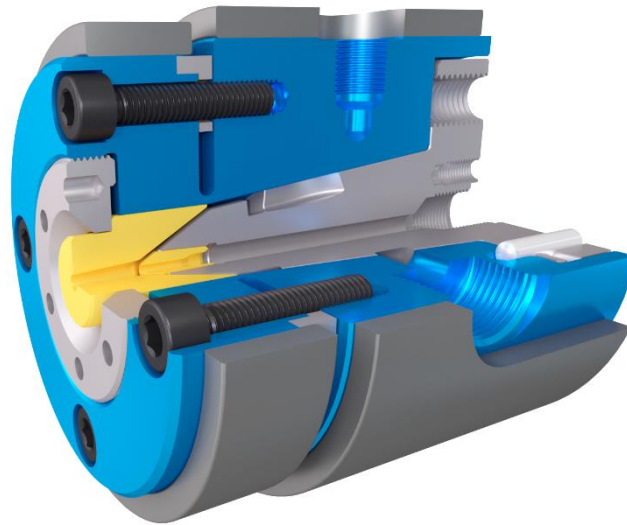



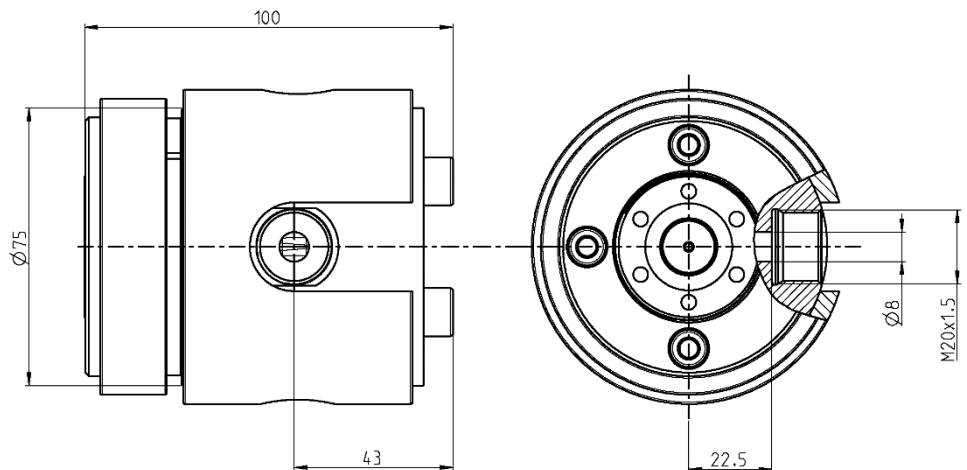



Power cable	
Data cable	
Special shaped	
Tube	

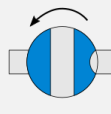

Version	Maximum opening of the Tip	Maximum opening of the Die	Main entry port / thread		Auxiliary entry port / thread		Total length	Crosshead diameter	Max. working temperature	Max. working pressure	Weight
			A	B	C	D					
-	2 mm	11 mm	8 mm	M20x1.5	-	-	100 mm	75 mm	<250°C	600 bars	3 kg

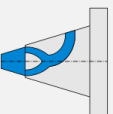
## Options

 Vacuum connection	 Extruder connection	 Bypass module	 Trolley or stand	 Customized distributor	 300°C Reinforced heaters					
--	--	--	---	---	---	--	--	--	--	--