







E45BN10

 Single layer	
 Fix/manual centring	 3 Heating zone(s)
 Die adjustment	

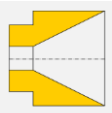
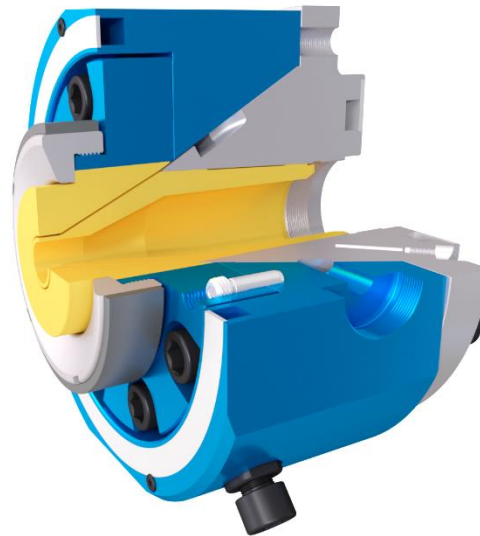



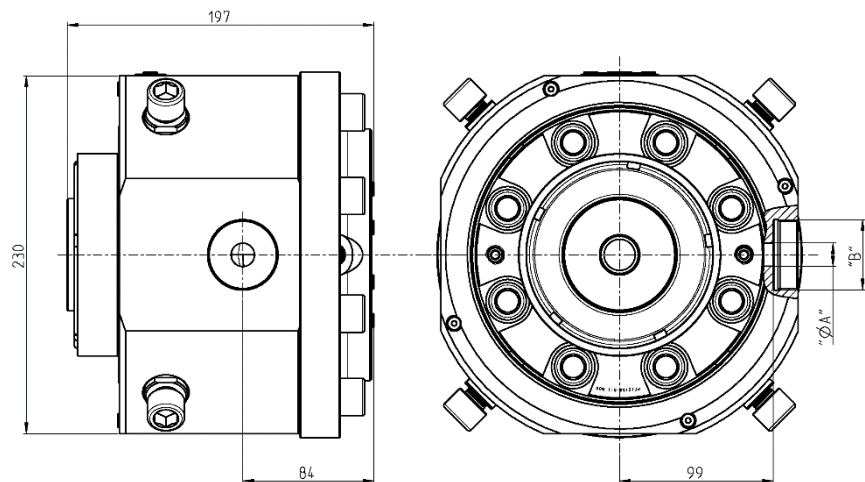



Power cable	
Data cable	
Special shaped	
Tube	

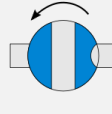
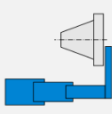

Version	Maximum opening of the Tip	Maximum opening of the Die	Main entry port / thread		Auxiliary entry port / thread		Total length	Crosshead diameter	Max. working temperature	Max. working pressure	Weight
			A	B	C	D					
Normal	45 mm	60 mm	15 mm	M45x1.5	-	-	197 mm	230 mm	<250°C	400 bars	50 kg
HFFR			20 mm	M50x1.5							

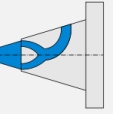
Options

 Vacuum connection	 Extruder connection	 Bypass module	 Telescopic maintenance device	 Trolley or stand	 Customized distributor	 300°C Reinforced heaters				
--	--	--	--	---	---	--	--	--	--	--