











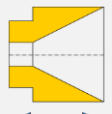
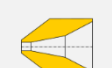
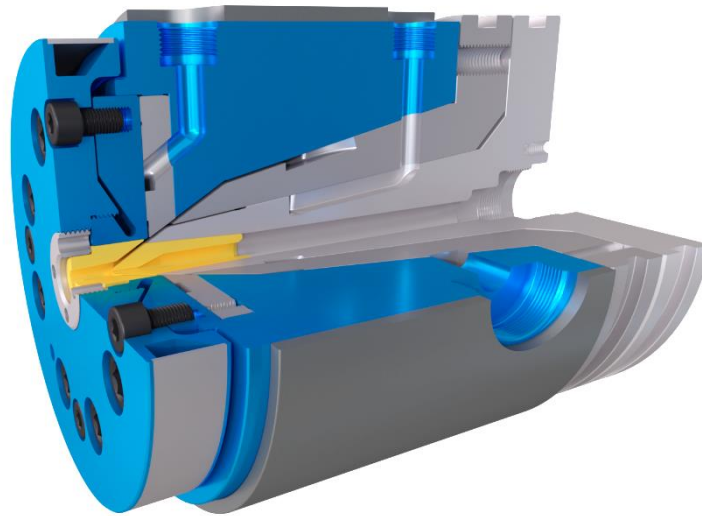

# E4GN21

 Multi-layers	 Skin coloration
 SFS	 Sectoral
 Striping	 Single layer
<b>FT</b> Fine-tuning centring	 2+ Heating zone(s)
 Die adjustment	
 Intermediate Die available	





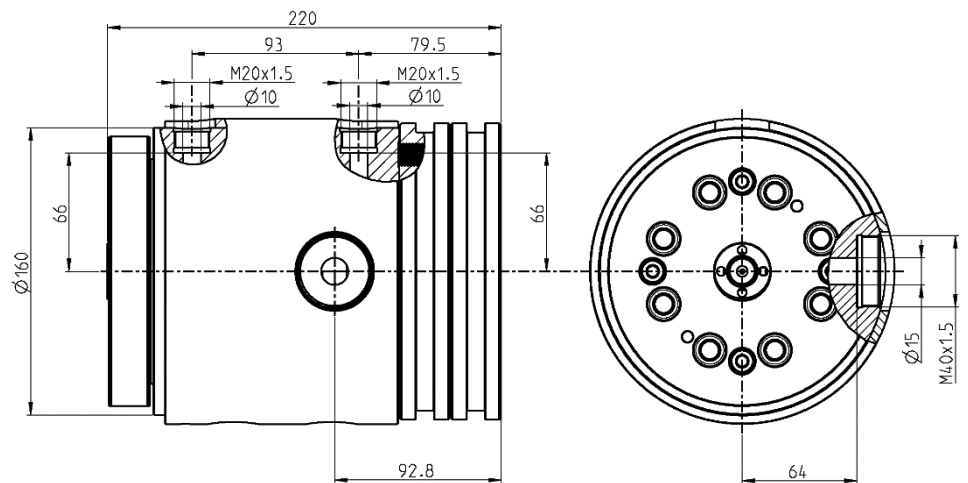

Power cable	
Data cable	
Special shaped	
Tube	
Multi-layer tube	
Foamed cable	

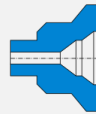
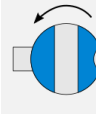
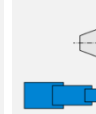

Version	Maximum opening of the Tip	Maximum opening of the Die	Main entry port / thread		Auxiliary entry port / thread		Total length	Crosshead diameter	Max. working temperature	Max. working pressure	Weight
			A	B	C	D					
-	7 mm	11 mm	15 mm	M40x1.5	10 mm	M20x1.5	220 mm	160 mm	<250°C	600 bars	34 kg

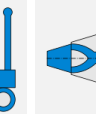
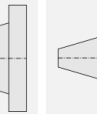
## Options

 Vacuum connection	 Extruder connection	 Bypass module	 Telescopic maintenance device	 Trolley or stand	 Customized distributor	 Heated distributor	 300°C Reinforced heaters		
--	--	--	--	---	---	--	---	--	--