









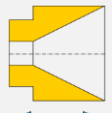
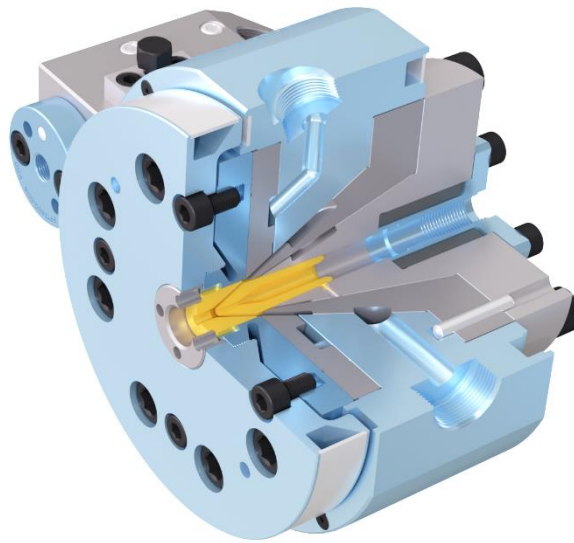

E4HF31

 SFS	 Skin coloration
 Striping	 Single layer
FT Fine-tuning centring	4  Heating zone(s)
 Die adjustment	



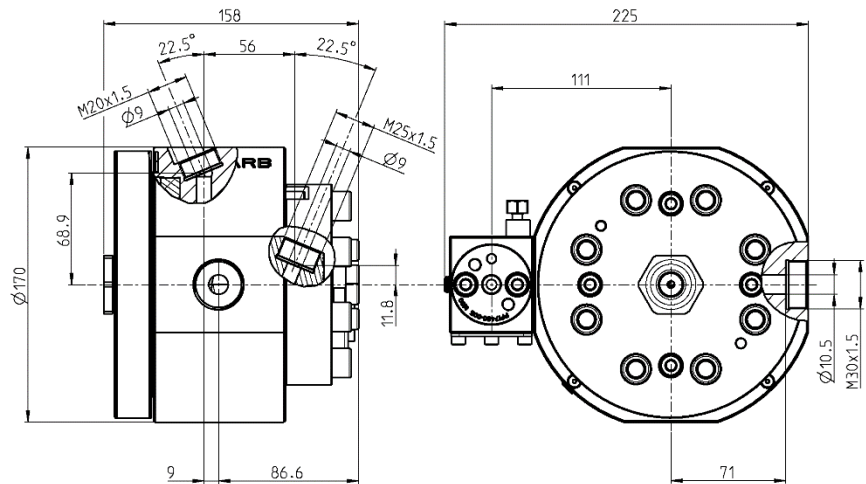

Power cable	
Data cable	
Special shaped	
Tube	
Foamed cable	



Version	Maximum opening of the Tip	Maximum opening of the Die	Main entry port / thread		Auxiliary entry port / thread		Total length	Crosshead diameter	Max. working temperature	Max. working pressure	Weight
			A	B	C	D					
	7 mm	11 mm	10.5 mm	M30x1.5	9 mm	M20x1.5	158 mm	170 mm	<400°C	500 bars	27 kg

Options

 Vacuum connection	 Extruder connection	 Bypass module	 Trolley or stand	 Customized distributor					
--	--	--	---	---	--	--	--	--	--