







E4K 4.1.0 BYPASS

 Single layer	
 Fix centring	 2 Heating zone(s)
 Die adjustment	

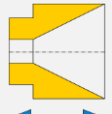
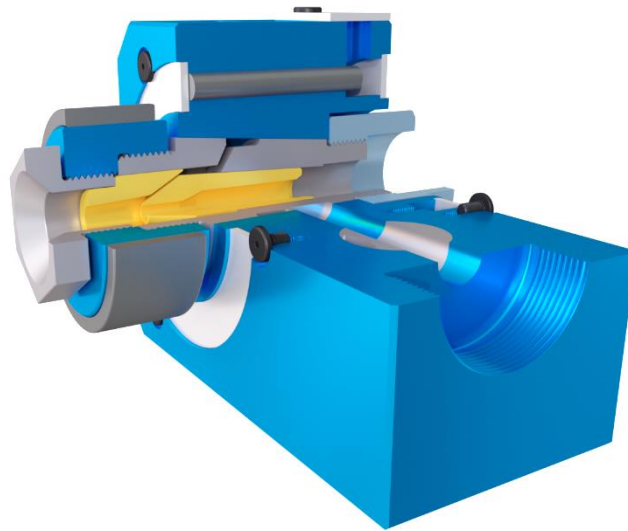



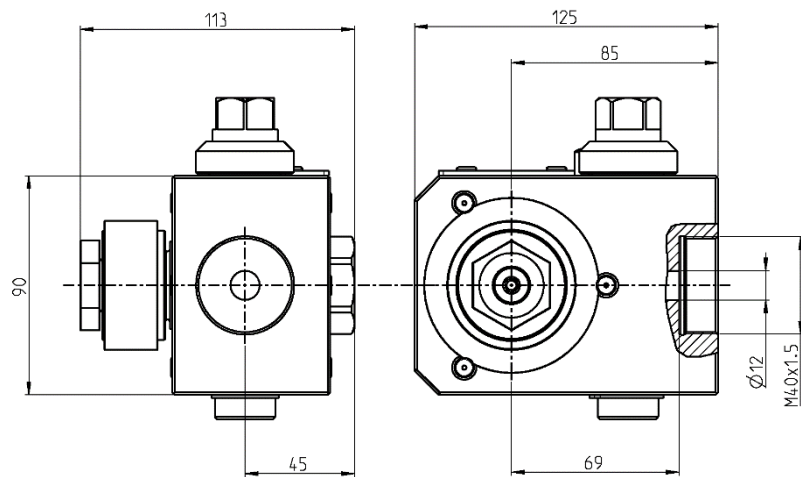

- Power cable 
- Data cable 
- Special shaped 
- Tube 



Version	Maximum opening of the Tip	Maximum opening of the Die	Main entry port / thread		Auxiliary entry port / thread		Total length	Crosshead diameter	Max. working temperature	Max. working pressure	Weight
			A	B	C	D					
-	7 mm	11 mm	12 mm	M40x1.5	-	-	113 mm	90 mm	<250°C	600 bars	6 kg

Options

 Vacuum connection	 Extruder connection	 Trolley or stand	 300°C Reinforced heaters							
----------------------------------------------------------------------------------------------------------	------------------------------------------------------------------------------------------------------------	---------------------------------------------------------------------------------------------------------	-----------------------------------------------------------------------------------------------------------------	--	--	--	--	--	--	--