









E4K 4.3.0 BYPASS

 Skin coloration	 Striping
 Single layer	
 Fix centring	 2 Heating zone(s)
 Die adjustment	

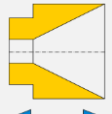
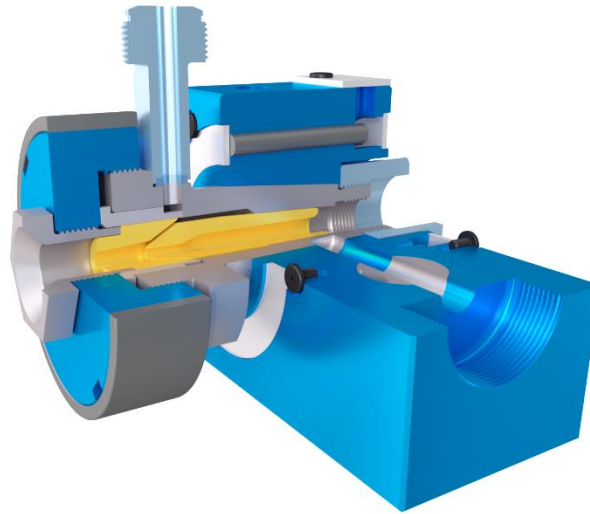



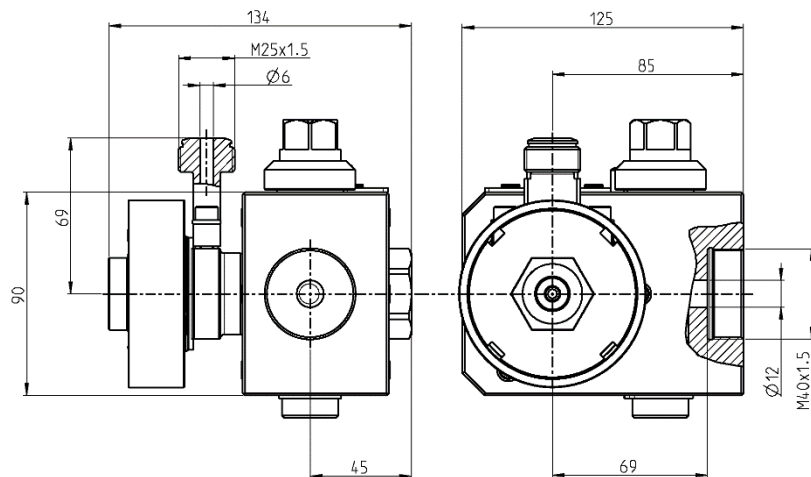

Power cable	
Data cable	
Special shaped	
Tube	

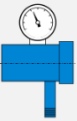

Version	Maximum opening of the Tip	Maximum opening of the Die	Main entry port / thread		Auxiliary entry port / thread		Total length	Crosshead diameter	Max. working temperature	Max. working pressure	Weight
			A	B	C	D					
-	7 mm	11 mm	12 mm	M40x1.5	6 mm	M25x1.5	134 mm	90 mm	<250°C	600 bars	7 kg

Options

 Vacuum connection	 Extruder connection	 Trolley or stand	 300°C Reinforced heaters							
--	--	---	---	--	--	--	--	--	--	--