









E4VN11 FT

 Skin coloration	 Striping
 Single layer	
FT Fine-tuning centring	2  Heating zone(s)
 Die adjustment	

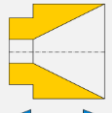
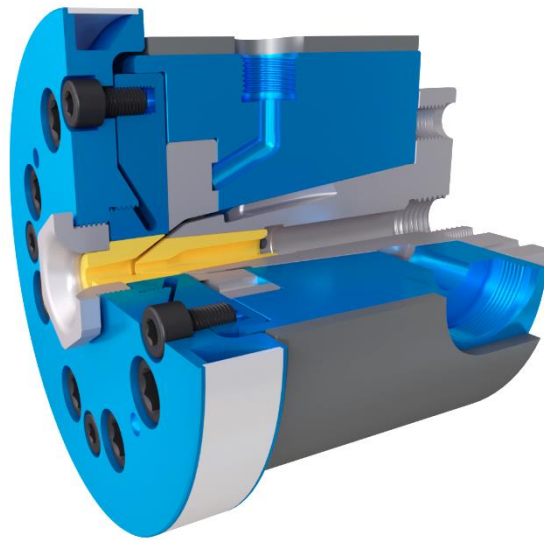



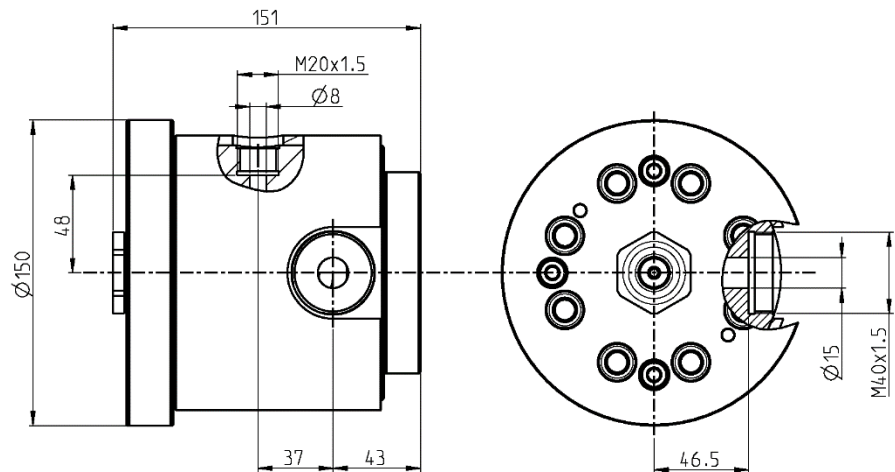



-  Power cable
-  Data cable
-  Special shaped
-  Tube

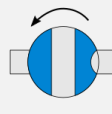

Version	Maximum opening of the Tip	Maximum opening of the Die	Main entry port / thread		Auxiliary entry port / thread		Total length	Crosshead diameter	Max. working temperature	Max. working pressure	Weight
			A	B	C	D					
-	7 mm	11 mm	15 mm	M40x1.5	8 mm	M20x1.5	151 mm	150 mm	<250°C	600 bars	13 kg

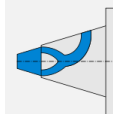
Options

 Vacuum connection	 Extruder connection	 Bypass module	 Trolley or stand	 Customized distributor	 300°C Reinforced heaters					
--	--	--	---	---	---	--	--	--	--	--